

LEMFÖRDER 

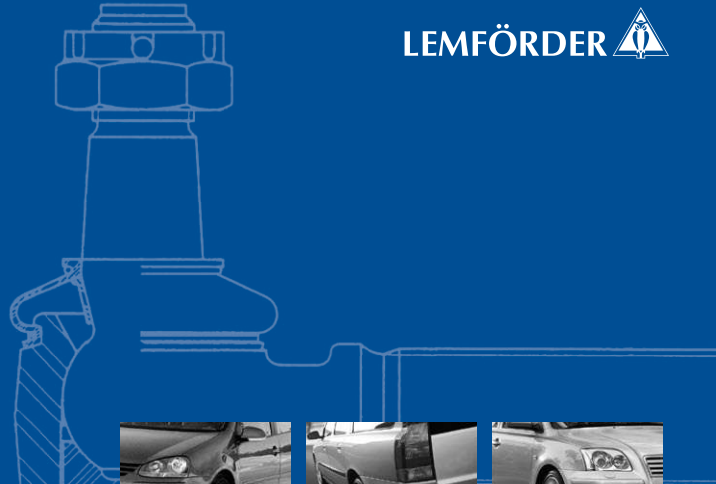

WV090001



Safety in Steering and Suspension

LEMFÖRDER 

Lemförder International AG & Co. KG
Borgwardstraße 16
28279 Bremen - Germany
Phone +49 (0)4 21 / 83 08-0
Fax +49 (0)4 21 / 83 08-299
lmi@lemfoerder.com
www.lemfoerder.com

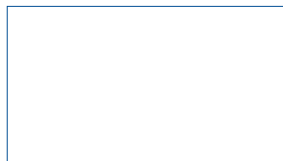

Aftermarket

LEMFÖRDER 



..... > LEMFÖRDER Passenger Cars: **Contents** < ...

LEMFÖRDER in passenger cars	4-5
Let quality decide	6-7
High-quality products	8-11
The information that counts	12-13
Passenger cars at a glance	5

LEMFÖRDER in passenger cars

We supply innovative precision products in the aftermarket for all leading car manufacturers.

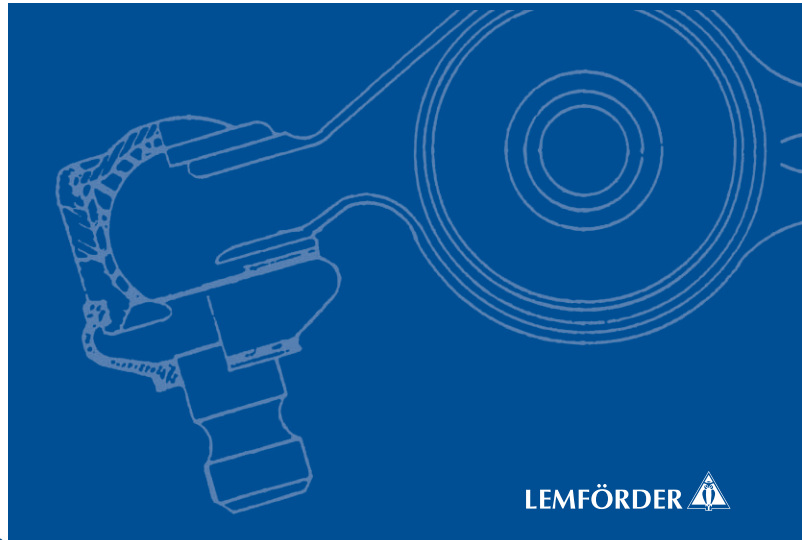
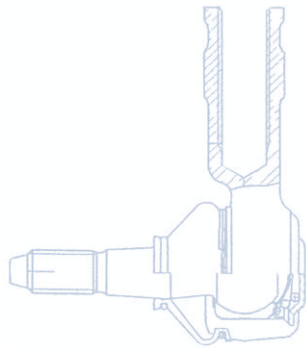

LEMFÖRDER 

... > **Reliability** in technology and quality <

Our many years of experience in steering and suspension technology speaks for itself. LEMFÖRDER, the brand for the aftermarket sector, provides internationally unique sales and service in the replacement parts market. You can rest assured that all products will meet your requirements in terms of the quality standard of the OE manufacturers. Why? Because we see the car as a whole: This means we take into account the frequently overlooked interactions between

the individual components and develop both professional and system-orientated solutions in close partnership with prominent car manufacturers. At the same time, the existing synergy effects in the concern are utilised intelligently. This makes our logo a guarantee for the utmost safety and highest quality.

Top-ranking car manufacturers throughout the world put their trust in ZF LEMFÖRDER expertise: Safety is of the utmost importance to them as well.

Audi > Aston-Martin > BMW > DaimlerChrysler > Fiat > Ford > GM / Opel > Honda > Isuzu > Jaguar > Jeep > Karmann > Land Rover > Mazda > MCC > MG > Mitsubishi > Nissan > Peugeot / Citroën > Porsche > Renault > Rolls-Royce > Rover Cars > Saab > Steyr-Daimler-Puch > Toyota > Volvo > Seat > Škoda > VW

Let quality decide

The automobile industry has already decided.



Climatic chambers



Computer analysis

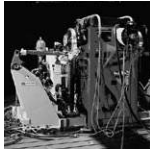

Axle test stand



Corrosion protection

... > **Put your trust** in the very best <

The LEMFÖRDER brand sets standards like no-one else.

The products developed for the LEMFÖRDER brand are optimised through to series standard in important inspections and field tests and subjected to the toughest conditions in special wear tests. This means safety and reliability in all conditions - as service and costs only make sense where high quality is systematically implemented.

We are always making comparisons. Why not try it as well – for your safety and that of your customers.

Only through the highest quality standards can the requirements for links be met in respect to wear and drive for example. Despite test requirements and accountability for safety features, there are clear differences in the market.

Comparison with the competition:

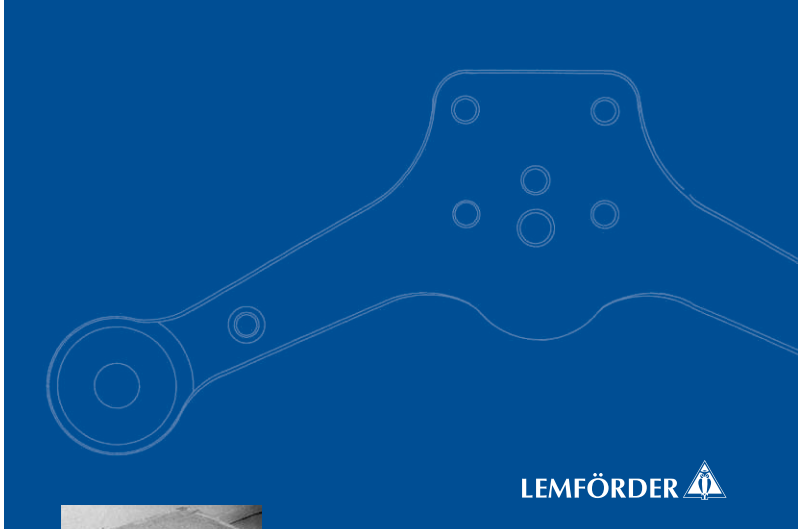
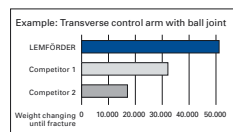

LEMFÖRDER



From blank to the finished prototype



Quality products

Experience reaching back decades pays for itself.



Multi-link rear axle BMW X5

... > **More of everything** you expect <



Front axle BMW X5

Our close contacts with the automobile industry as well as commerce and workshops enable us to optimise our product range to market requirements. Our full-service assembly for optimising repair workflows plays a prominent role here. This, of course, applies for all product groups of the LEMFÖRDER brand.

LEMFÖRDER steering and suspension components

- >> Axial joint
- >> Axial tie rod
- >> Ball joint
- >> Control arm
- >> Idler arm
- >> Pitman arm
- >> Stabilizer link
- >> Suspension joint
- >> Tie rod
- >> Tie rod end

Our steering and suspension components are safety parts which are subject to particular care in construction, manufacturing and assembly.

LEMFÖRDER steering components and rubber composites

- >> Engine and transmission bearing
- >> Link and stabilizer link joint bearing
- >> Rubber bowl and flexible disc
- >> Special bearing
- >> Strut mounting
- >> Subframe bearing

Our steering components and rubber composites are designed for a long service life.

LEMFÖRDER brake parts

- >> Brake discs
- >> Brake drums
- >> Brake pads
- >> Brake sensors
- >> Brake shoes

All our brake parts are safety components that accept no compromise.

LEMFÖRDER power transmission elements

- >> Belt tensioner pulleys
- >> Idler pulleys
- >> Ribbed belts
- >> Timing belts
- >> V-belts

Our drive elements ensure a reliable power transmission.



The information that counts

Our flexibility gives our customers the advantage.



Catalogues



Training CD



Internet / Online catalogue



Education / Training



... > **Optimum solutions, the fast and accurate way** < ...



We not only work very closely with our customers, but regard each other as partners. That means we don't just simply supply the vehicle parts, but also provide technical and commercial support through our trained personnel on site, on the Internet or by telephone, fax or email.

We also support our partners

- >> through a comprehensive catalogue
- >> through an online catalogue
- >> through marketing measures
- >> through training courses
- >> through material to support our training

This way we give our customers valuable tools in order to secure a profitable partnership in the long-term.

Trust depends on people

LEMFÖRDER is the brand of an internationally active, expanding and market-orientated service company. The brand stands for steering and suspension expertise in the aftermarket. We have achieved this status thanks to a close cooperation with our customers and business partners based on mutual trust. Our expertise has enabled us to achieve a market position today which will guarantee us continued and healthy growth in the future as well. It will come as no surprise, then, that the quality of our products and services plays a crucial role in this.

Our employees

– committed, creative, motivated. These qualities are the success behind our ability to turn your requirements into reality. Our objective is to ensure they are satisfied. Our international presence means we provide flexible working times, thus eliminating the problem of time zones. As a company that is constantly seeking new ways to improve itself, we will be delighted to meet the challenges you set us.

